



tune°

PAPE+ROHDE
b ü r o e i n r i c h t u n g e n

Inhaltsverzeichnis	Kapitel	Contents	Chapter
Oberflächen - Farben	01.01 - 01.04	surfaces - colours	01.01 - 01.04
Erläuterungen	02.01 - 02.02	explanations	02.01 - 02.02
Arbeitsstische	03.01 - 03.04	work stations	03.01 - 03.04
Tische, rechteckig		rectangular work stations	
Tische, angewinkelt		angled work stations	
Tische, Freiform		free form work stations	
Ankettische	04.01 - 04.03	add-on desks	04.01 - 04.03
Ankettung rechtwinklig		90 deg. connection	
Ankettung linear		linear connection	
Zwischenplatten		intermediate tops	
Ankettische, Besprechung		add-on conference desks	
Besprechungstische, rund	05.01	conference desks, round	05.01
Kabelmanagement	06.01	cable management	06.01
Zubehör	07.01 - 07.04	accessories	07.01 - 07.04
Monitorarme		monitor arms	
Aufsatzwände		table top screens	
Ablageborde		elevated shelves	
Rückwände		modesty panels	
CPU-Halter		CPU stand	
Druckerbord		printer shelf	
Schiebetür-Anstellelemente	08.01	side cupboard units with sliding door	08.01

Artikelbezeichnung und Farbkennung

Zur eindeutigen Bestimmung eines Artikels ist die Angabe
• der Artikelbezeichnung und
• der Farbkennung erforderlich.

In Artikelbezeichnungen, die Varianten enthalten, müssen eine oder mehrere Angaben, z. B. zu Oberfläche oder Plattennummer, eingesetzt werden.

Die einzusetzenden Zeichen entsprechen der Anzahl der Sternchen (*).

Optionen werden durch Ergänzungen zur Artikelbezeichnung gekennzeichnet. Zum Teil muss für die Optionen ein Aufpreis addiert werden.

Die Anzahl der notwendigen Farbangaben variiert von Artikel zu Artikel. Die Reihenfolge ist durch Nummerierung definiert.

TOTR	1-	08-	G1-	SM	-OB	-K2L	056/049-057
Tiefe:	80 cm						
Breite:	80 cm						
Gestellform:	Gestellform G1						
Variante:	Oberfläche: Spanplatte Melamin						
Option:	Organisationsbohrungen						
Option:	Kabeldurchlass links aus Metall						
Notwendige Farbangaben:							
1. Gestell: helium							
2. Platte: kristallweiß							
Option -K2L: hochglanzchrom							

Article reference and colour code

For the exact article definition the following details are required:
• the article reference and
• the colour code

Articles which are available in different variants have to be completed with one or more details such as the surface or the desk number. The number of stars (*) shows the number of symbols which have to be indicated. Options will be added to the article reference and the up-charge for some options has to be added to the basic article price.

The number of required colour codes is different for each article. The sequence is defined by the numbering.

TOTR	1-	08-	G1-	SM	-OB	-K2L	056/049-057
depth:	80 cm						
width:	80 cm						
desk frame:	type G1						
variant:	surface: chipboard melamine						
option:	organisation holes						
option:	cable outlet made of metal left						
necessary colour details:							
1. frame: helium							
2. top: cristal white							
option -K2L: mirror finish							

Bei diesen Artikeln sind unbedingt Farbangaben bei der Bestellung notwendig:

Colours of the following articles must be indicated in the order:

Artikel	article	Farbcode / colour code
Tische, Anketttische, Zwischenplatten, Besprechungstische, Ablageborde, Druckerbord	work stations, add-on desks, intermediate tops, conference desks, elevated shelves, printer shelf	- 021, 022, 023, 029, 055, 056**, 068
- Gestell bzw. Metallteile*	- frame or metal parts*	- 011, 024, 026, 041, 042, 049, 051, 052, 080, 081, 082, 111, 122, 131, 132, 141, 161, 171, 181, 191
- Platte (Spanplatte)	- top (chipboard)	- 041, 049, Kante schwarz / edge black
- Compactplatte	- solid core laminate (scl)	- bei Spanplatten / chipboard : 014, 044, 049
Kabeldurchlass aus Kunststoff	cable outlet made of plastic	- bei Compactplatten: Material u. Farbe wie Platte scl: material and colour same as scl-top
Kabeldurchlass aus Metall	cable outlet made of metal	- 057, 059
Kabelwanne*	cable tray*	- 021, 022, 023, 029, 055, 056, 068
Kabelschlange	cable chain	- 014, 045
CPU-Halter*	CPU stand*	- 021, 022, 023, 029, 055, 056, 068
Rückwände	modesty panels	- 021, 022, 023, 029, 055, 056, 068
- Metallteile*	- metal parts*	- transluzent / translucent
- Rückwand	- modesty panel	
Aufsatzwände	table top screens	- 021, 022, 023, 029, 055, 056, 068
- Metallteile*	- metal parts*	- siehe Prospekt Oberflächen, see brochure surfaces
- Stoffbezug	- fabric	
Anstellelemente	side cupboard units	
- Korpus	- carcass	- 011, 014, 024, 026, 041, 042, 049, 051, 052, 072, 080, 081, 082
- Abdeckplatte und Front	- top and front	- 011, 014, 024, 026, 041, 042, 049, 051, 052, 072, 080, 081, 082, 111, 122, 131, 132, 141, 161, 171, 181, 191
- Traversenrohre*	- cross bars*	- 021, 022, 023, 029, 055, 056, 068

Diese Artikel haben immer folgende Farbausführung:

These articles are available only with the following colours:

Artikel	article	Farbcode / colour code
Abdeckstopfen f. Organisationsbohrung	cover for organisation holes	Edelstahl / stainless steel
Monitorarm	monitor arm	silber metallic / silver metallic
Zubehör für Aufsatzwände	accessories for table top screens	silber struktur / silver structure
Zubehör für Anstellelemente	accessories for side cupboard units	schwarz / black
Griff Form A / N / M	handle type A / N / M	Alu farblos eloxiert / clear anodised aluminium
Griff Form B	handle type B	Edelstahl / stainless steel
Griff Form G / I / K	handle type G / I / K	matt verchromt / matt chrome-plated
Griff J	handle type J	Alu farblos eloxiert und hochglanzchrom / clear anodised aluminium and mirror finish

Farbkürzel / colour codes

011	lichtgrau	light grey	057	hochglanzchrom	mirror finish
014	schwarz	black	059	matt verchromt	matt chrome-plated
021	schwarz struktur	black structure	068	graphit struktur	graphite structure
022	silber struktur	silver structure	072	graphit	graphite
023	lichtgrau struktur	light grey structure	080	Pflaume Dekor	plum decor
024	Buche Dekor	beech decor	081	Kirschbaum Dekor	cherry tree decor
026	Ahorn Dekor	maple decor	082	Olive dunkel Dekor	olive wood decor
029	silber metallic	silver metallic	111	Echtholz Buche	beech veneer
041	weißaluminium	aluminium white	122	Echtholz Esche schwarz offenporig	ash tree open-pored veneer
042	Weißbuche Dekor	light beech decor	131	Echtholz Ahorn europäisch	European maple veneer
044	alugrau	aluminium grey	132	Echtholz Ahorn kanadisch	Canadian maple veneer
045	transluzent	translucent	141	Echtholz Schweizer Birnbaum	Swiss pearwood veneer
049	kristallweiß	crystal white	161	Echtholz Nussbaum	walnut veneer
051	Balearen Eiche Dekor	Balearic oak decor	171	Echtholz Zebrano	zebrano veneer
052	Zebrano Dekor	zebrano decor	181	Echtholz Eiche	oak veneer
055	kristallweiß struktur	crystal white structure	191	Echtholz Kirschbaum	cherry veneer
056	helium	helium			

Wichtiger Hinweis:

Holz ist ein gewachsener Werkstoff. Kein Stamm gleicht dem anderen. Die einzelnen Stämme unterscheiden sich in Maserung und Farbe. Aber auch innerhalb eines Stammes treten Struktur- und Tonunterschiede auf. Unter Lichteinwirkung und durch extrem feuchtes oder extrem trockenes Klima kann sich die Holzfarbe ändern. **Unterschiede, Unregelmäßigkeiten und Veränderungen, die aufgrund der natürlichen Beschaffenheit des Holzes auftreten, sind kein Grund zur Beanstandung.** Die Furniere werden sorgfältig und kommissionsweise ausgewählt. Soweit möglich verwenden wir für einen Auftrag Furnier aus einem Stamm. Dadurch werden die Unterschiede in Struktur und Färbung so gering wie möglich gehalten. Bei Nachlieferungen sind Unterschiede in Struktur und Färbung kein Grund zur Beanstandung.

Important note:

Wood is a grown material. No trunk of a tree is alike the other. The single trunks are different in grain and colour. Also within a trunk there are differences in structure and tone. When exposed to light radiation and in an extremely humid or extremely dry climate the wood colour can change. **Differences and changes caused by the natural quality of the wood are no reason for complaint.** The veneer will be chosen carefully and separately for each commission. As far as possible we use veneer of the same trunk for one order. This helps to keep differences in structure and colour as low as possible.

Differences in structure and colour are no reason for complaint in subsequent deliveries.

Platte (Melamin)
Top (melamine surface)



024
Buche Dekor
beech decor



026
Ahorn Dekor
maple decor



042
Weißbuche Dekor
light beech decor



051
Balearen Eiche Dekor
Balearic oak decor



052
Zebrano Dekor
zebrano decor



080
Pflaume Dekor
plum decor

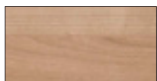

081
Kirschbaum Dekor
cherry tree decor



082
Olive dunkel Dekor
olive wood decor

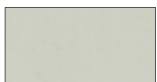

011
lichtgrau
light grey

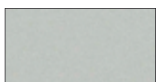

041
weißaluminium
aluminium white



049
kristallweiß
crystal white

Platte (Furnier Echtholz)
Top (veneer surface real wood)



111
Echtholz Buche
beech veneer

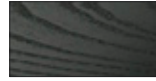

122
Echtholz Esche schwarz offenporig
ash tree open-pored veneer



131
Echtholz Ahorn europäisch
European maple veneer



132
Echtholz Ahorn kanadisch
Canadian maple veneer



141
Echtholz Schweizer Birnbaum
Swiss pearwood veneer



161
Echtholz Nussbaum
walnut veneer



171
Echtholz Zebrano
zebrano veneer



181
Echtholz Eiche
oak veneer



191
Echtholz Kirschbaum
cherry veneer

Compactplatte
Solid core laminate

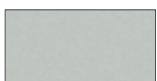

041
weißaluminium
aluminium white



049
kristallweiß
crystal white

Kante schwarz / edge black

Gestell- / Metallteile*
Frame / metal parts*



021
schwarz struktur
black structure



055
kristallweiß struktur
crystal white structure



022
silber struktur
silver structure

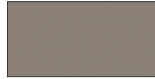

056**
helium
helium



023
lichtgrau struktur
light grey structure



068
graphit struktur
graphite structure



029
silber metallic
silver metallic

Kabeldurchlass aus Kunststoff
Cable outlet made of plastic



014
schwarz
black



057
hochglanzchrom
mirror finish



044
alugrau
aluminium grey



059
matt verchromt
matt chrome-plated



049
kristallweiß
crystal white

Bei Compactplatten: Material u. Farbe wie Platte
scl: material and colour same as scl-top

Kabelschlange
Cable chain

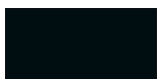











014
schwarz
black

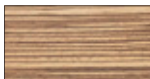

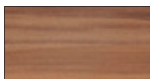

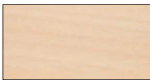
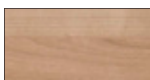





045
transluzent
translucent

Farbabweichungen zu den Originaloberflächen sind möglich / Colours may vary from actual material

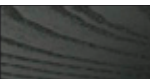





Anstellelement: Korpus, Abdeckplatte / Front (Melamin)
Side cupboard unit: carcass, cupboard top / front (melamine surface)

	011 lichtgrau light grey		024 Buche Dekor beech decor		052 Zebrano Dekor zebrano decor
	014 schwarz black		026 Ahorn Dekor maple decor		080 Pflaume Dekor plum decor
	041 weißaluminium aluminium white		042 Weißbuche Dekor light beech decor		081 Kirschbaum Dekor cherry tree decor
	049 kristallweiß crystal white		051 Balearen Eiche Dekor Balearic oak decor		082 Olive dunkel Dekor olive wood decor
	072 graphit graphite				

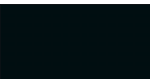
Anstellelement: Abdeckplatte / Front (Furnier Echtholz)
Side cupboard unit: cupboard top / front (veneer surface real wood)

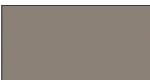
	111 Echtholz Buche beech veneer		161 Echtholz Nussbaum walnut veneer
	122 Echtholz Esche schwarz offenporig ash tree open-pored veneer		171 Echtholz Zebrano zebrano veneer
	131 Echtholz Ahorn europäisch European maple veneer		181 Echtholz Eiche oak veneer
	132 Echtholz Ahorn kanadisch Canadian maple veneer		191 Echtholz Kirschbaum cherry veneer
	141 Echtholz Schweizer Birnbaum Swiss pearwood veneer		

Anstellelement: Traversenrohre*
Side cupboard unit: cross bars*

	021 schwarz struktur black structure		055 kristallweiß struktur crystal white structure
	022 silber struktur silver structure		056 helium helium
	023 lichtgrau struktur light grey structure		068 graphit struktur graphite structure
	029 silber metallic silver metallic		

Farbabweichungen zu den Originaloberflächen sind möglich / Colours may vary from actual material

- Arbeitshöhe 72 cm
- mit Option Höheneinstellung Ausgangshöhe einstellbar von 65 - 85 cm in 1 cm Schritten
- working height 72 cm
- with height adjustment (optional) initial height adjustable from 65 - 85 cm in 1 cm steps

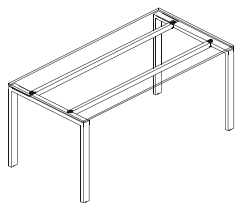
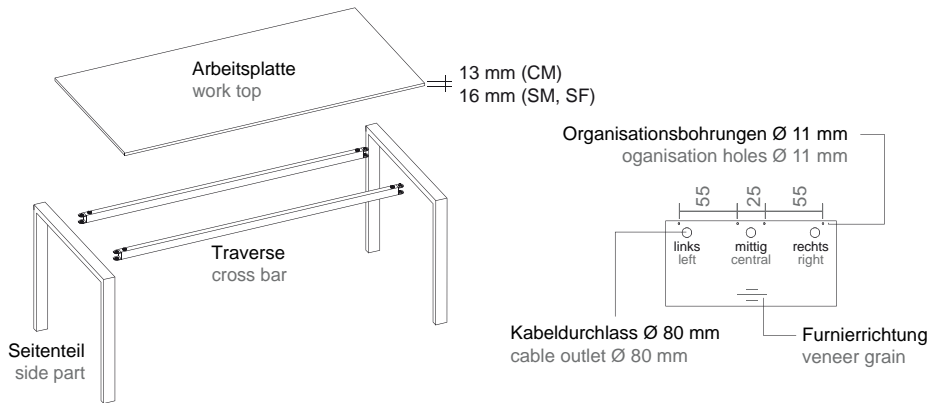

Gestellform G1
frame form G1

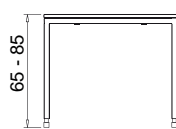
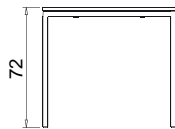

mit Höheneinstellung
with height adjustment

Hinweis:
Produktfremdes Zubehör für die Organisationsbohrungen muss zusätzlich stabilisiert werden! Wir bitten um Rücksprache.

Important note:
Non-product related accessories for organisation holes need additional stabilisation! Please consult us on this.

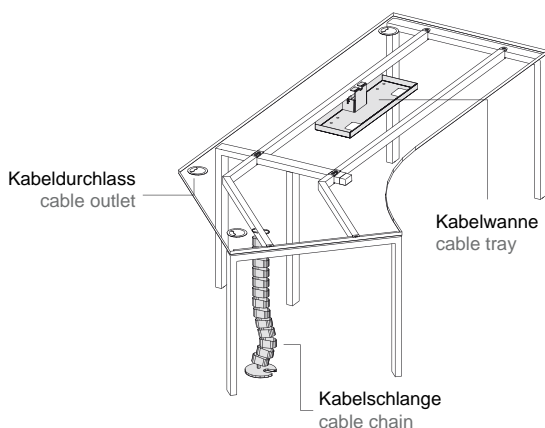

- Kabeldurchlässe, \varnothing 80 mm, in zwei Ausführungen
- horizontal: Kabelwanne, 60 und 80 cm breit, verschiebbar an der Traverse
- vertikal: Kabelschlange
- weiteres Zubehör: Systemverkabelung, Steckerleistenbefestigung, Desktop-Steckerleiste - siehe separate Preisliste "Systemverkabelung"
- cable outlet, \varnothing 80 mm, two versions
- horizontal: cable tray, 60 and 80 cm wide, adjustable on the cross bar
- vertical: cable chain
- further accessories: plug panels, main connection cables, plug panel fixing, desktop power modules - see separate price list "Electrical Accessories"

Arbeitstisch
work desk

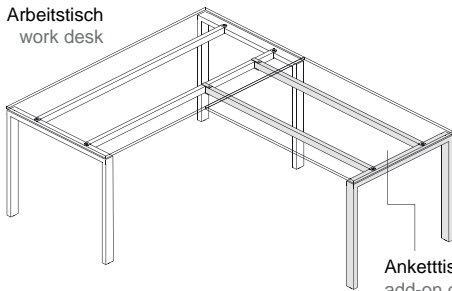

Ankettisch, rechteckig
add-on desk,
90 deg. connection

- Ankettung rechteckig
- Ankettung links und rechts möglich, da Gestelle symmetrisch
- 90 deg. connection
- symmetrical frames enable a connection on the left and right side

Arbeitstisch
work desk

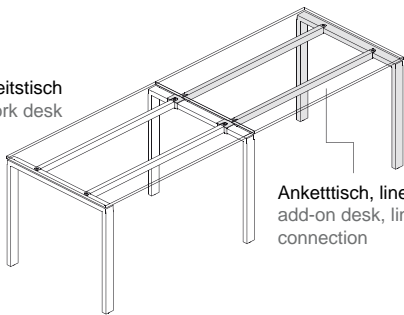

Ankettisch, linear
add-on desk, linear
connection

- Ankettung linear
- Ankettung links und rechts, da Gestelle symmetrisch
- linear connection
- symmetrical frames enable a connection on the left and right side

Arbeitstisch
work desk

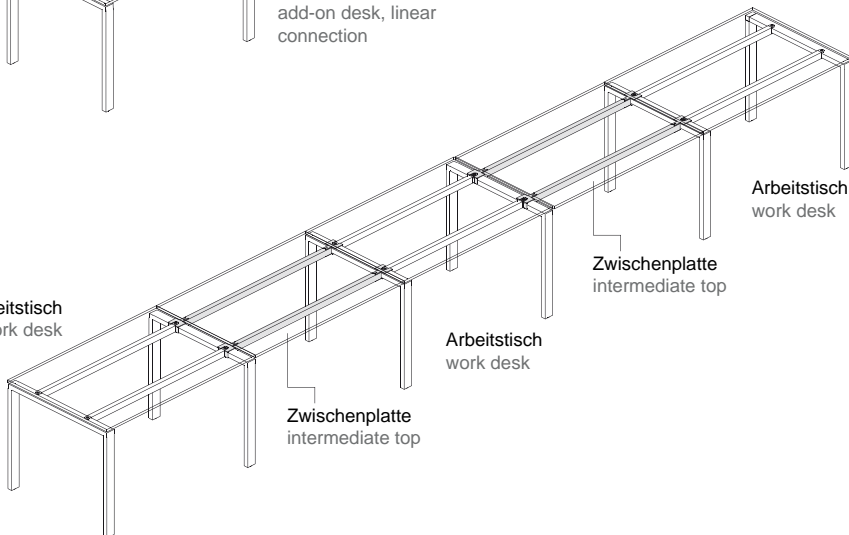

Zwischenplatte
intermediate top

Arbeitstisch
work desk

Arbeitstisch
work desk

Zwischenplatte
intermediate top

- Reihentische - abwechselnd Arbeitstisch und Zwischenplatte
- benches consist of work desk and intermediate tops alternately assembled

Arbeitstisch
work desk

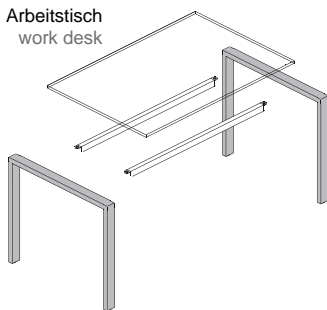



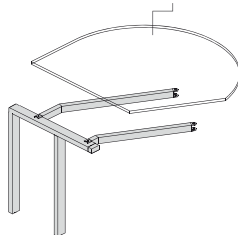



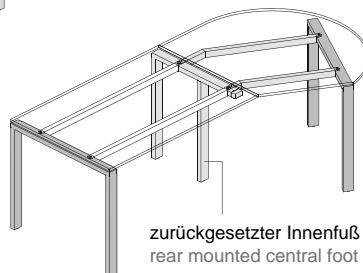



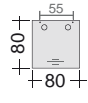

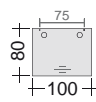
Ankettisch, Besprechung
add-on conference desk

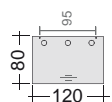

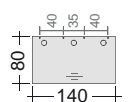

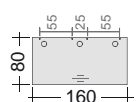
- ankettbare Besprechungstische mit zurückgesetztem Innenfuß
- add-on conference desks with rear mounted central foot

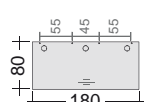

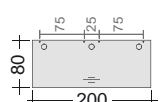
zurückgesetzter Innenfuß
rear mounted central foot

Tische, rechteckig		rectangular work stations				
		Trägermaterial: Oberfläche: basic material: surface:	Spanplatte Melamin chipboard melamine	Spanplatte Echtholz chipboard real wood	Compactplatte Melamin scl melamine	Höhenein- stellung height adjustment
			SM	SF	CM	
		TOTR1-08-G1- **				
		TOTR1-10-G1- **				
		TOTR1-12-G1- **				
		TOTR1-14-G1- **				
		TOTR1-16-G1- **				
		TOTR1-18-G1- **				
		TOTR1-20-G1- **				
Notwendige Farbangaben: Necessary colour details:		1. Gestell / frame	2. Platte / top			

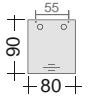
Optionen		options	
Option	Beschreibung	description	Preis / price
-K1L / -K1R / -K1M	Kabeldurchlass aus Kunststoff links, rechts, mittig	cable outlet made of plastic left, right, central position	à
-K2L / -K2R / -K2M	Kabeldurchlass aus Metall links, rechts, mittig	cable outlet made of metal left, right, central position	à
Notwendige Farbangaben / Necessary colour details:		3. Kabeldurchlass / cable outlet	
-OB	Organisationsbohrungen	organisation holes	

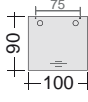
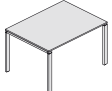
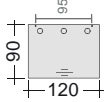
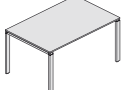
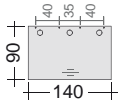
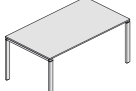
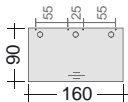
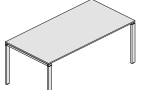
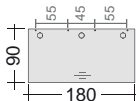
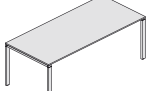
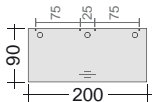
Tische, rechteckig		rectangular work stations				
		Trägermaterial: Oberfläche: basic material: surface:	Spanplatte Melamin chipboard melamine	Spanplatte Echtholz chipboard real wood	Compactplatte Melamin scl melamine	Höhenein- stellung height adjustment
			SM	SF	CM	
		TOTR2-08-G1- **				
		TOTR2-10-G1- **				
		TOTR2-12-G1- **				
		TOTR2-14-G1- **				
		TOTR2-16-G1- **				
		TOTR2-18-G1- **				
		TOTR2-20-G1- **				
Notwendige Farbangaben: Necessary colour details:		1. Gestell / frame	2. Platte / top			

Optionen			options
Option	Beschreibung	description	Preis / price
-K1L / -K1R / -K1M	Kabeldurchlass aus Kunststoff links, rechts, mittig	cable outlet made of plastic left, right, central position	à
-K2L / -K2R / -K2M	Kabeldurchlass aus Metall links, rechts, mittig	cable outlet made of metal left, right, central position	à
Notwendige Farbangaben / Necessary colour details:			3. Kabeldurchlass / cable outlet
-OB	Organisationsbohrungen	organisation holes	

Tische, angewinkelt







angled work stations

	Plattenform / work top shape	Trägermaterial: Oberfläche: basic material: surface:	Spanplatte Melamin chipboard melamine	Spanplatte Echtholz chipboard real wood	Compactplatte Melamin scl melamine	Höhenein- stellung height adjustment
			SM	SF	CM	
		TOTA1- **- G1- **				
		TOTA1- **- G1- **				
		TOTA1- **- G1- **				
		TOTA1- **- G1- **				
		TOTA1- **- G1- **				
		TOTA1- **- G1- **				
Notwendige Farbangaben: Necessary colour details:		1. Gestell / frame	2. Platte / top			

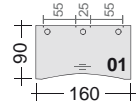
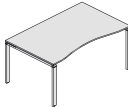
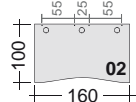
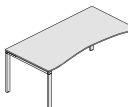
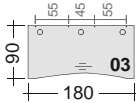
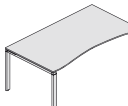
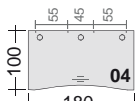
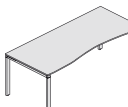
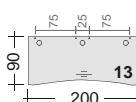
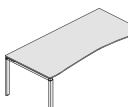
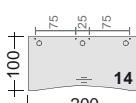
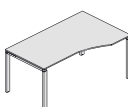
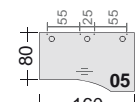
Optionen

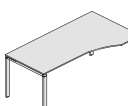
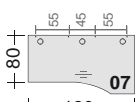
options

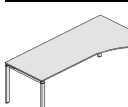
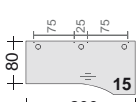
Option	Beschreibung	description	Preis / price
-K1L / -K1R / -K1M	Kabeldurchlass aus Kunststoff links, rechts, mittig	cable outlet made of plastic left, right, central position	à
-K2L / -K2R / -K2M	Kabeldurchlass aus Metall links, rechts, mittig	cable outlet made of metal left, right, central position	à
Notwendige Farbangaben / Necessary colour details:		3. Kabeldurchlass / cable outlet	
-OB	Organisationsbohrungen	organisation holes	







Tische, Freiform		free form work stations				
Plattenform / work top shape		Trägermaterial: Oberfläche: basic material: surface:	Spanplatte Melamin chipboard melamine	Spanplatte Echtholz chipboard real wood	Compactplatte Melamin scl melamine	Höhenein- stellung height adjustment
			SM	SF	CM	
		TOTF1- 01- G1- **				
		TOTF1- 02- G1- **				
		TOTF1- 03- G1- **				
		TOTF1- 04- G1- **				
		TOTF1- 13- G1- **				
		TOTF1- 14- G1- **				
	 	TOTF1- **- G1- **				
	 	TOTF1- **- G1- **				
	 	TOTF1- **- G1- **				
Notwendige Farbangaben: Necessary colour details:		1. Gestell / frame	2. Platte / top			

Optionen			options
Option	Beschreibung	description	Preis / price
-K1L / -K1R / -K1M	Kabeldurchlass aus Kunststoff links, rechts, mittig	cable outlet made of plastic left, right, central position	à
-K2L / -K2R / -K2M	Kabeldurchlass aus Metall links, rechts, mittig	cable outlet made of metal left, right, central position	à
Notwendige Farbangaben / Necessary colour details:			3. Kabeldurchlass / cable outlet
-OB	Organisationsbohrungen	organisation holes	

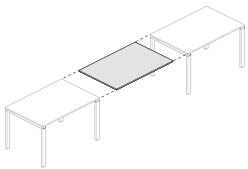
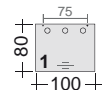

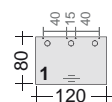
Ankettische, Ankeftung rechtwinklig		add-on desks, 90 deg connection				
<p>Ankeftung links und rechts möglich, da Gestelle symmetrisch Symmetrical frames enable a connection on the left and right side</p>		Trägermaterial:	Spanplatte	Spanplatte	Compactplatte	Höheneinstellung height adjustment
		Oberfläche:	Melamin	Echtholz	Melamin	
		basic material:	chipboard	chipboard	scl	
		surface:	melamine	real wood	melamine	
			SM	SF	CM	
	TOAR1-10-G1-	**				
	TOAR1-12-G1-	**				
	TOAR1-14-G1-	**				
	TOAR1-16-G1-	**				
	TOAR1-18-G1-	**				
<p>Notwendige Farbangaben: Necessary colour details:</p>		1. Gestell / frame	2. Platte / top			

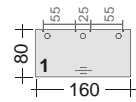

Ankettische, Ankeftung linear		add-on desks, linear connection				
<p>Ankeftung links und rechts möglich, da Gestelle symmetrisch Symmetric frames enable a connection on the left and right</p>		Trägermaterial:	Spanplatte	Spanplatte	Compactplatte	Höheneinstellung height adjustment
		Oberfläche:	Melamin	Echtholz	Melamin	
		basic material:	chipboard	chipboard	scl	
		surface:	melamine	real wood	melamine	
			SM	SF	CM	
	<i>Plattentiefe / depth of work top</i>					
	<p>80 cm TOAL 1- 10-G1- **</p> <p>90 cm TOAL 2- 10-G1- **</p>					
	<p>80 cm TOAL 1- 12-G1- **</p> <p>90 cm TOAL 2- 12-G1- **</p>					
	<p>80 cm TOAL 1- 16-G1- **</p> <p>90 cm TOAL 2- 16-G1- **</p>					
<p>Notwendige Farbangaben: Necessary colour details:</p>		1. Gestell / frame	2. Platte / top			



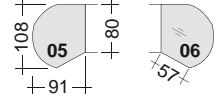

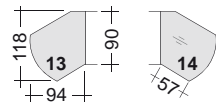
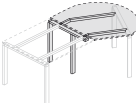
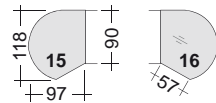
Optionen			options
Option	Beschreibung	description	Preis / price
-K1L / -K1R / -K1M	Kabeldurchlass aus Kunststoff links, rechts, mittig	cable outlet made of plastic left, right, central position	à 17,-
-K2L / -K2R / -K2M	Kabeldurchlass aus Metall links, rechts, mittig	cable outlet made of metal left, right, central position	à 47,-
<p>Notwendige Farbangaben / Necessary colour details:</p>			3. Kabeldurchlass / cable outlet
-OB	Organisationsbohrungen	organisation holes	34,-

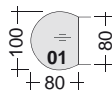
Zwischenplatten		intermediate tops			
		Trägermaterial: Oberfläche: basic material: surface:	Spanplatte Melamin chipboard melamine	Spanplatte Echtholz chipboard real wood	Compactplatte Melamin scl melamine
	Plattentiefe / depth of work top		SM	SF	CM
			80 cm TUZW 1- 10- **		
			90 cm TUZW 2- 10- **		
			80 cm TUZW 1- 12- **		
			90 cm TUZW 2- 12- **		
			80 cm TUZW 1- 16- **		
			90 cm TUZW 2- 16- **		
Notwendige Farbangaben: Necessary colour details:		1. Metallteile / metal parts	2. Platte / top		

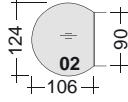
Optionen		options	
Option	Beschreibung	description	Preis / price
-K1L / -K1R / -K1M	Kabeldurchlass aus Kunststoff links, rechts, mittig	cable outlet made of plastic left, right, central position	à
-K2L / -K2R / -K2M	Kabeldurchlass aus Metall links, rechts, mittig	cable outlet made of metal left, right, central position	à
Notwendige Farbangaben / Necessary colour details:		3. Kabeldurchlass / cable outlet	
-OB	Organisationsbohrungen	organisation holes	

Ankettische Besprechung, Gruppe 1		add-on conference desks, group 1				
<p>Aufbau siehe Kapitel 02 basic structure see chapter 02</p>		<p>Trägermaterial: Oberfläche: basic material: surface:</p>	Spanplatte Melamin	Spanplatte Echtholz	Compactplatte Melamin	Höhenein- stellung height adjustment
			chipboard melamine	chipboard real wood	scl melamine	
Plattenform / work top shape		SM	SF	CM		
		TOAB1-**-G1-**				
		TOAB1-**-G1-**				
		TOAB1-**-G1-**				
<p>Notwendige Farbangaben: Necessary colour details:</p>		1. Gestell / frame	2. Platte / top			

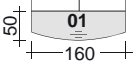
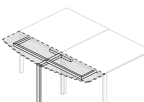
Ankettische Besprechung, Gruppe 2		add-on conference desks, group 2				
<p>Ankettung links und rechts möglich, da Gestelle symmetrisch Symmetrical frames enable a connection on the left and right side</p>		<p>Trägermaterial: Oberfläche: basic material: surface:</p>	Spanplatte Melamin	Spanplatte Echtholz	Compactplatte Melamin	Höhenein- stellung height adjustment
			chipboard melamine	chipboard real wood	scl melamine	
Plattenform / work top shape		SM	SF	CM		
		TOAB2-01-G1-**				
		TOAB2-02-G1-**				
<p>Notwendige Farbangaben: Necessary colour details:</p>		1. Gestell / frame	2. Platte / top			

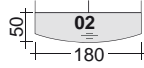
Ankettische Besprechung, Gruppe 3		add-on conference desks, group 3				
<p>Ankettung links und rechts möglich, da Gestelle symmetrisch Symmetrical frames enable a connection on the left and right side</p>		<p>Trägermaterial: Oberfläche: basic material: surface:</p>	Spanplatte Melamin	Spanplatte Echtholz	Compactplatte Melamin	Höhenein- stellung height adjustment
			chipboard melamine	chipboard real wood	scl melamine	
Plattenform / work top shape		SM	SF	CM		
			TOAB3-01-GN-**			
			TOAB3-02-GN-**			
<p>Notwendige Farbangaben: Necessary colour details:</p>		1. Gestell / frame	2. Platte / top			

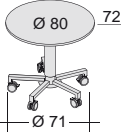
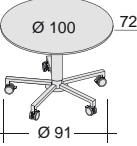
Besprechungstische, fahrbar, starr		mobile conference desks, fixed height			
		Trägermaterial: Oberfläche: basic material: surface:	Spanplatte Melamin chipboard melamine	Spanplatte Echtholz chipboard real wood	Compactplatte Melamin scl melamine
			SM	SF	CM
					
	TUBR1-08-	**			
					
	TUBR1-10-	**			
Notwendige Farbangaben: Necessary colour details:		1. Gestell / frame	2. Platte / top		

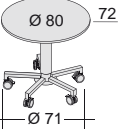
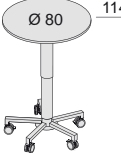
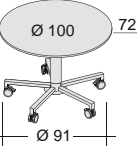
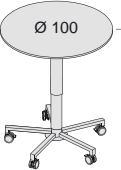
Besprechungstische, fahrbar, höhenverstellbar		height adjustable and mobile conference desks			
			SM	SF	CM
					
	TUBR2-08-	**			
					
	TUBR2-10-	**			
Notwendige Farbangaben: Necessary colour details:		1. Gestell / frame	2. Platte / top		

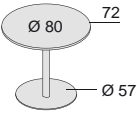
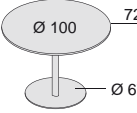
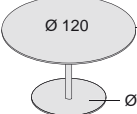
Besprechungstische, starr		fixed conference desks			
			SM	SF	CM
					
	TUBR3-08-	**			
					
	TUBR3-10-	**			
					
	TUBR3-12-	**			
Notwendige Farbangaben: Necessary colour details:		1. Gestell / frame	2. Platte / top		

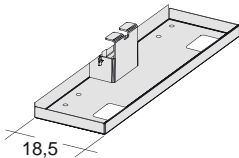
Kabelwanne		cable tray	
Befestigung (werkzeugfrei) an der Traverse / fixed on the cross bar (without tools)		Breite / width	
	<i>Preis ohne Steckerleiste / price without plug panel</i>	60 cm	TUKW1- 06
		80 cm	TUKW1- 08
		Notwendige Farbangaben / Necessary colour details:	

- inkl. 2 Einfach-Kabelbügel
- with 2 cable bows

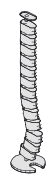
Kabelschlange		cable chain	
		für Traverse / for cross bar	TUKKS-RO
		für Kabelwanne / for cable tray	TUKKS-KW
		Notwendige Farbangaben / Necessary colour details:	

Kabelsets		cabling sets	
Verkabelungsset 1 (bestehend aus Kabelwanne 60 cm breit, Kabelschlange mit Befestigung in der Kabelwanne, Steckerleiste mit Netzanschlusskabel 3 m und Befestigung in der Kabelwanne, VPE Klett-Kabelbinder) cabling set 1 (consisting of cable tray 60 cm wide, cable chain fixed in the cable tray, plug panel with mains connection cable 3 m long, fixed in the cable tray, 1 packing unit Velcro tape)		TUVKSE- 01	
Verkabelungsset 2 (bestehend aus Kabelwanne 80 cm breit, Kabelschlange mit Befestigung in der Kabelwanne, Steckerleiste mit Netzanschlusskabel 3 m und Befestigung in der Kabelwanne, VPE Klett-Kabelbinder) cabling set 2 (consisting of cable tray 80 cm wide, cable chain fixed in the cable tray, plug panel with mains connection cable 3 m long, fixed in the cable tray, 1 packing unit Velcro tape)		TUVKSE- 02	
Notwendige Farbangaben:		1. Metallteile / metal parts	
Necessary colour details:		2. Kabelschlange / cable chain	

- Steckerleiste generell schwarz
- plug panel generally in black

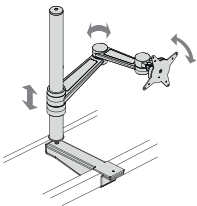

in der Tiefe dynamisch verstellbar, Bildschirm max. 8 kg, inkl. Schnellverschluss
dynamic adjustable in depth, monitor max. 8 kg, incl. quick release

TUZMA1

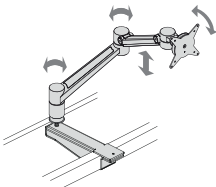

komplett dynamisch verstellbar, Bildschirm max. 7 kg, inkl. Schnellverschluss
completeley dynamic adjustable, monitor max. 7 kg, incl. quick release

TUZMA2

- für eine Organisationsbohrung
- nach VESA-Standard gefertigt (75 bzw. 100 mm Interface)
- inkl. Stahl-Tragarm zur Befestigung an Traverse

- for one organisation hole
- according to VESA standard (75 or 100 mm interface)
- with steel support arm fixed on the cross bar

Aufsatzwand, 4 cm stark		table top screen, 4 cm thick		
		Anbindung: adaptation:	Einzel single	Doppel double
Breite / width			E1	D1
80 cm	TUAW- 08- **		545,--	509,--
100 cm	TUAW- 10- **		571,--	532,--
120 cm	TUAW- 12- **		595,--	559,--
140 cm	TUAW- 14- **		623,--	587,--
160 cm	TUAW- 16- **		650,--	614,--
180 cm	TUAW- 18- **		686,--	650,--
200 cm	TUAW- 20- **		730,--	694,--
Notwendige Farbangaben: Necessary colour details:		1. Metallteile / metal parts	2. Stoff / fabric	

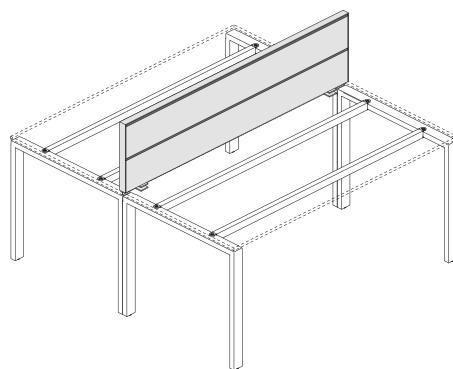
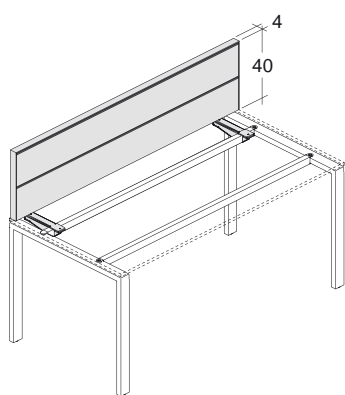



Aufsatzelemente mit hervorragenden akustischen Eigenschaften:

- Aluminiumrahmenprofil
- Füllstoff Brandklasse B1
- 100% recycelbar
- beidseitig organisierbar durch zwei waagrechte Systemschienen zum Einhängen von Zubehör

Table top screen with excellent acoustic properties:

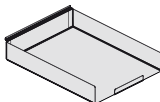
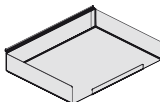
- aluminium frame
- filling material fire class B1
- 100% recyclable
- with two organisation rails on both sides for accessories

Zubehör für die Aufsatzwand		accessories for the table top screen	
	Briefablage DIN A4 längs letter storage DIN A4, lengthwise	TUAWZBL	
	Briefablage DIN A4 quer letter storage DIN A4, crosswise	TUAWZBQ	
	Utensilien-Ablage utensil storage	TUAWZUT	
	Stiftköcher pencil box	TUAWZSK	

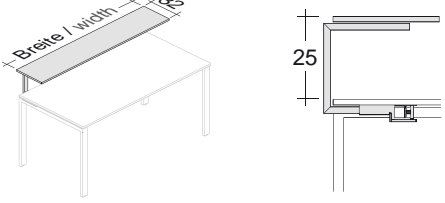
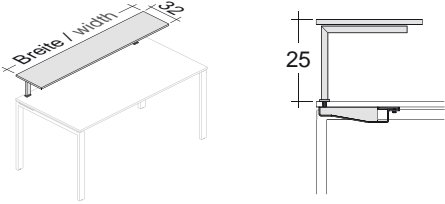
Ablageborde		elevated shelves			
		Trägermaterial: Oberfläche: basic material: surface:	Spanplatte Melamin chipboard melamine	Spanplatte Echtholz chipboard real wood	Compactplatte Melamin scl melamine
		Breite / width	SM	SF	CM
 <p>an der Traverse on the cross bar</p>	80 cm	TUZA1- 08- **			
	100 cm	TUZA1- 10- **			
	120 cm	TUZA1- 12- **			
	140 cm	TUZA1- 14- **			
	160 cm	TUZA1- 16- **			
	30 x 32 cm	TUZA1- 01- **			
	 <p>für Organisationsbohrungen for organisation holes</p>	80 cm	TUZA2- 08- **		
100 cm		TUZA2- 10- **			
120 cm		TUZA2- 12- **			
140 cm		TUZA2- 14- **			
160 cm		TUZA2- 16- **			
30 x 32 cm		TUZA2- 01- **			
Notwendige Farbangaben: Necessary colour details:		1. Metallteile / metal parts		2. Platte / top	

- Ablageborde zur Befestigung an der Traverse:
Position frei wählbar
(Hinweis: die bündige Montage eines 80 cm breiten Bords an eine 140 cm breite Tischplatte sowie eines 140 cm breiten Bords an eine 200 cm breiter Tischplatte würde den mittleren Kabeldurchlass blockieren)
- Ablageborde zur Befestigung in den Organisationsbohrungen:
für Rücken-an-Rücken-Aufstellungen
Bordbreite = Abstand Organisationsbohrungen + 25 cm (siehe Beschreibung der Tische)

- elevated shelves fixed on the cross bar:
no restriction for position
(note: the flush assembly of a 80 cm wide shelf to a 140 cm wide top and a 140 cm wide shelf to a 200 cm wide top would block the central cable outlet)
- elevated shelves fixed in the organisation holes:
for back-to-back-configurations
width of shelf = distance between the organisation holes + 25 cm
(see desk description)

Rückwände		modesty panels	
Befestigung an der Traverse / fixed on the cross bar		für Tischbreite / for desk width	
		80 cm	TUZR1- 08
		100 cm	TUZR1- 10
		120 cm	TUZR1- 12
		140 cm	TUZR1- 14
		160 cm	TUZR1- 16
		180 cm	TUZR1- 18
		200 cm	TUZR1- 20
Notwendige Farbangaben für Befestigungsmaterial: Necessary colour details for fixing material:		Metallteile / metal parts	

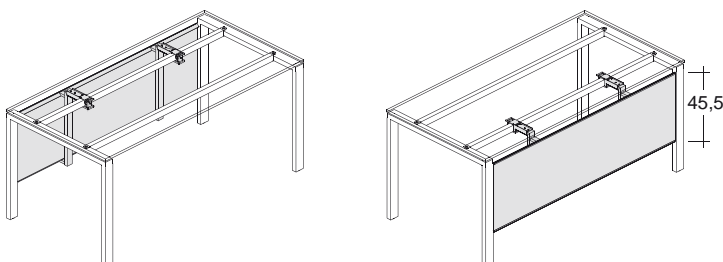

- nicht in Verbindung mit 80 cm breiter Kabelwanne (TUKW1-08)
- not possible in conjunction with 80 cm wide cable tray (TUKW1-08)

CPU-Halter, Typ 1 **CPU stand, type 1**

Befestigung am Seitenteil / attachment to side part **TUZC1**

Notwendige Farbangaben / Necessary colour details: *Metallteile / metal parts*

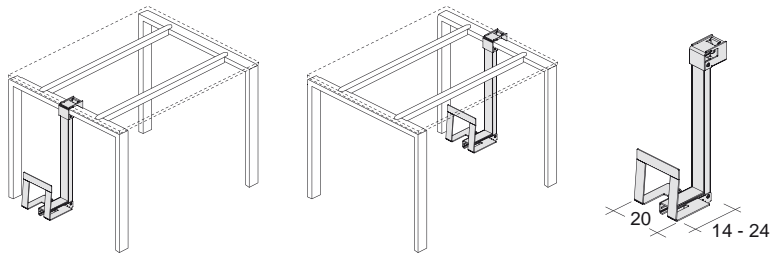

- für beide Gestellformen, Befestigung am Gestell links oder rechts
 - nach innen und außen montierbar
 - max. Nutzhöhe 47,5 cm bei Innenmontage, 56 cm bei Außenmontage
 - max. Belastbarkeit 25 kg
 - nicht für Reihenaufstellung geeignet
 - inkl. 2 Einfach-Kabelbügel
- for both frame types, fixed on the frame left or right
 - fixed inside and/or outside
 - max. height of the CPU 47,5 cm when fixed inside, when fixed outside 56 cm
 - max. load bearing capacity 25 kg
 - not suitable for setting up in a row
 - with 2 cable bows

CPU-Halter, Typ 2 **CPU stand, type 2**

Befestigung zwischen den Traversenrohren, Tischtiefe 80 cm / attachment between cross bars, depth of desk 80 cm **TUZC2-08**

Befestigung zwischen den Traversenrohren, Tischtiefe 90 cm / attachment between cross bars, depth of desk 90 cm **TUZC2-09**

Notwendige Farbangaben / Necessary colour details: *Metallteile / metal parts*

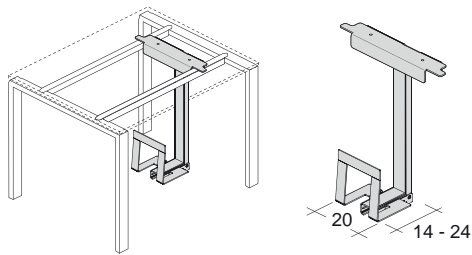

- für beide Gestellformen, verschiebbar
 - max. Nutzhöhe 47,5 cm
 - max. Belastbarkeit 25 kg
 - für Reihenaufstellung geeignet
 - inkl. 2 Einfach-Kabelbügel
- for both frame types, adjustable
 - max. height of the CPU 47,5 cm
 - max. load bearing capacity 25 kg
 - suitable for setting up in a row
 - with 2 cable bows

Druckerbord **printer shelf**

	Spanplatte Melamin chipboard melamine	Spanplatte Echtholz chipboard real wood	Compactplatte Melamin scl melamine
	SM	SF	CM
TUZDB- **			

Notwendige Farbangaben: **1. Metallteile / metal parts** **2. Platte / top**
Necessary colour details:

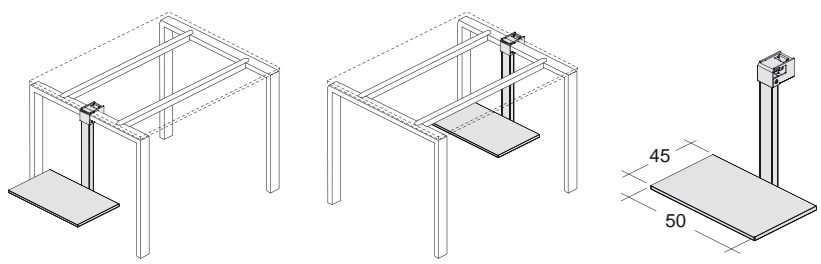

- Befestigung am Gestell links oder rechts
 - nach innen und außen montierbar
 - max. Nutzhöhe 37 cm bei Innenmontage, 46 cm bei Außenmontage (bis Oberkante Tisch)
 - max. Belastbarkeit 20 kg
 - nicht für Reihenaufstellung geeignet
- fixed on the frame left or right
 - fixed inside and/or outside
 - max. height of the printer 37 cm when fixed inside, when fixed outside 46 cm (up to upper edge at desk top)
 - max. load bearing capacity 20 kg
 - not suitable for setting up in a row

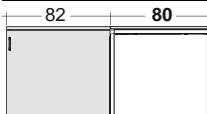
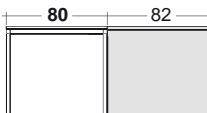
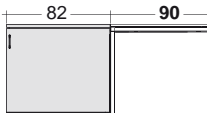
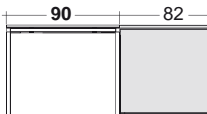
Schiebetür-Anstellelemente				side cupboard units with sliding door							
inkl. Griff -GN inkl. Holz-Einlegeboden incl. handle -GN incl. wooden shelf		Oberfläche Abdeckplatte/Front: surface of the top/front:		Melamin melamine	Echtholz real wood veneer	Compactplatte scl	Griffe handles		Griffe handles		verschießbar lockable
für Tischtiefe / for desk depth				SM	SF	CM					
	links / left	80 cm	TUAEL-08-*				-GA -GB -GG -GI	-GJ -GK -GM		-VS	
	rechts / right	80 cm	TUAER-08-*				-GA -GB -GG -GI	-GJ -GK -GM		-VS	
	links / left	90 cm	TUAEL-09-*				-GA -GB -GG -GI	-GJ -GK -GM		-VS	
	rechts / right	90 cm	TUAER-09-*				-GA -GB -GG -GI	-GJ -GK -GM		-VS	
Notwendige Farbangaben: Necessary colour details:		1. Korpus / carcass		2. Abdeckplatte und Front / top and front							

Traversenrohre		cross bars
Gestell für Einzeltische, 80 cm tief, links angestellt / frame for single desks, 80 cm deep, left position		TUATL-08
Gestell für Einzeltische, 80 cm tief, rechts angestellt / frame for single desks, 80 cm deep, right position		TUATR-08
Gestell für Einzeltische, 90 cm tief, links angestellt / frame for single desks, 90 cm deep, left position		TUATL-09
Gestell für Einzeltische, 90 cm tief, rechts angestellt / frame for single desks, 90 cm deep, right position		TUATR-09
Verbindungsrohre für Doppelarbeitsplatz, jeweils 80 cm tief / connection bars for double desks, 80 cm deep each		TUATD-08
Verbindungsrohre für Doppelarbeitsplatz, jeweils 90 cm tief / connection bars for double desks, 90 cm deep each		TUATD-09
Notwendige Farbangaben: / Necessary colour details:		Gestell / frame

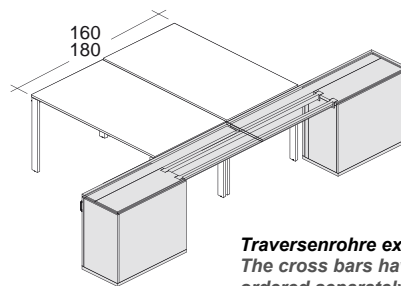
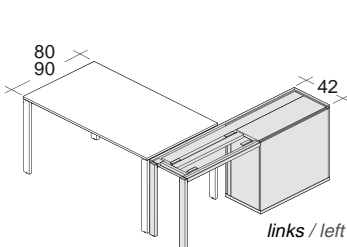

- Schiebetür-Anstellelement unabhängig vom Arbeitstisch
- Elemente mit Hängerahmen bieten keinen zusätzlichen Stauraum für Ordner
- the side cupboard unit with sliding door is not fixed at the work desk
- units with a A4 filing frame do not offer additional storage for ring binders

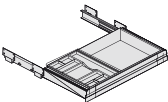
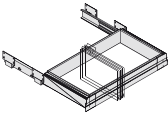
Inneneinteilungen - auch zur nachträglichen Montage		interior accessoires - also for later assembly
	Breitschub mit Materialschale organisation drawer with pencil tray	TUAE-BS3
	pro Element ist nur 1 Hängerahmen möglich! only 1 filing frame possible for each unit!	Auszug für A4-Hängemappen A4 filing frame
Holz-Einlegeboden / wooden shelf		TUAE-080/04-ZHEB
Notwendige Farbangaben: / Necessary colour details:		Korpus / carcass

